

22406
20516
QU 24257/8

BOSCH

GBH 4 DFE

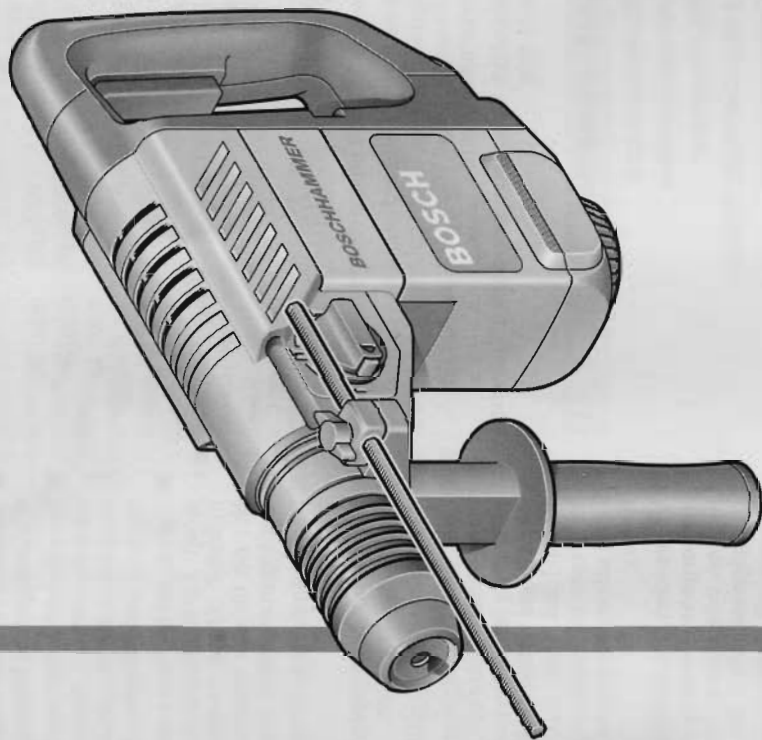

Bedienungsanleitung
Operating Instructions
Instructions d'emploi
Instrucciones de servicio
Manual de instruções
Istruzioni d'uso
Gebruiksaanwijzing
Betjeningsvejledning
Bruksanvisning
Brukerveiledningen
Käyttöohje
Οδηγία Χειρισμού
Kullanım kılavuzu

Deutsch
English
Français
Español
Português
Italiano
Nederlands
Dansk
Svenska
Norsk
Suomi
Ελληνικά
Türkçe

BOSCH 

Robert Bosch GmbH
Geschäftsbereich Elektrowerkzeuge
70745 Leinfelden-Echterdingen
www.bosch-pt.com

1 619 929 432 (02.08) O / 72

Printed in Germany · Imprimé en Allemagne

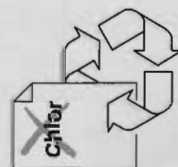

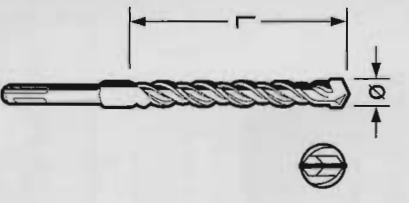

Ø (mm)	L (mm)	Ø (mm)	L (mm)
3,5	50	10	50
4	50	100	100
4	100	150	150
5	50	100	200
5	100	250	250
5	150	300	300
5,5	50	10	400
5,5	100	10	550
5,5	150	11	100
5,5	200	11	150
6	50	11	200
6	100	11	250
6	150	12	100
6	200	12	150
6,5	50	12	200
6,5	100	12	250
6,5	150	12	400
6,5	200	13	100
6,5	250	13	150
7	50	13	200
7	100	14	100
7	150	14	150
8	50	14	200
8	100	14	250
8	150	14	400
8	200	15	100
8	400	15	200
8	550	16	150
9	100	16	250
9	150		

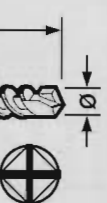

Ø (mm)	L (mm)
16	400
18	200
18	400
20	200
20	400
22	400
24	400
25	400
28	400
30	400

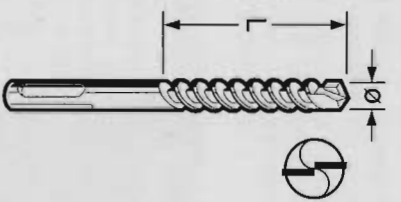

Ø (mm)	L (mm)	Ø (mm)	L (mm)
10	950	20	150
12	550	20	250
12	950	20	400
14	550	20	550
14	950	20	950
15	400	22	200
16	400	22	400
16	550	22	550
16	750	22	750
16	950	22	950
17	150	23	200
18	150	24	200
18	250	24	400
18	400	25	200
18	550	25	400
18	750	25	950
18	950	26	200
19	150	26	400
19	250	26	750
19	400		

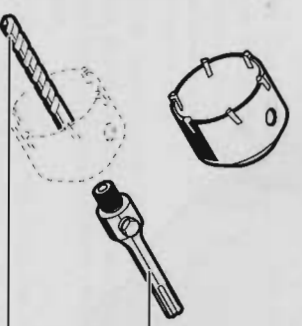

Ø 40 mm	2 608 550 074
Ø 50 mm	2 608 550 075
Ø 68 mm	2 608 550 076
Ø 82 mm	2 608 550 077
L = 110 mm	2 608 550 057
L = 220 mm	2 608 598 110
Ø 8 mm	2 608 596 157

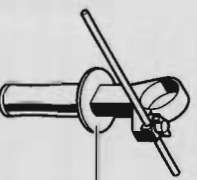

2 602 025 077

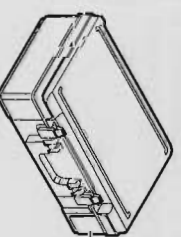

2 605 438 389

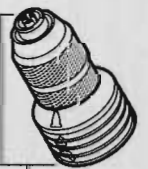

2 608 572 146
SDS-plus:
2 608 572 059

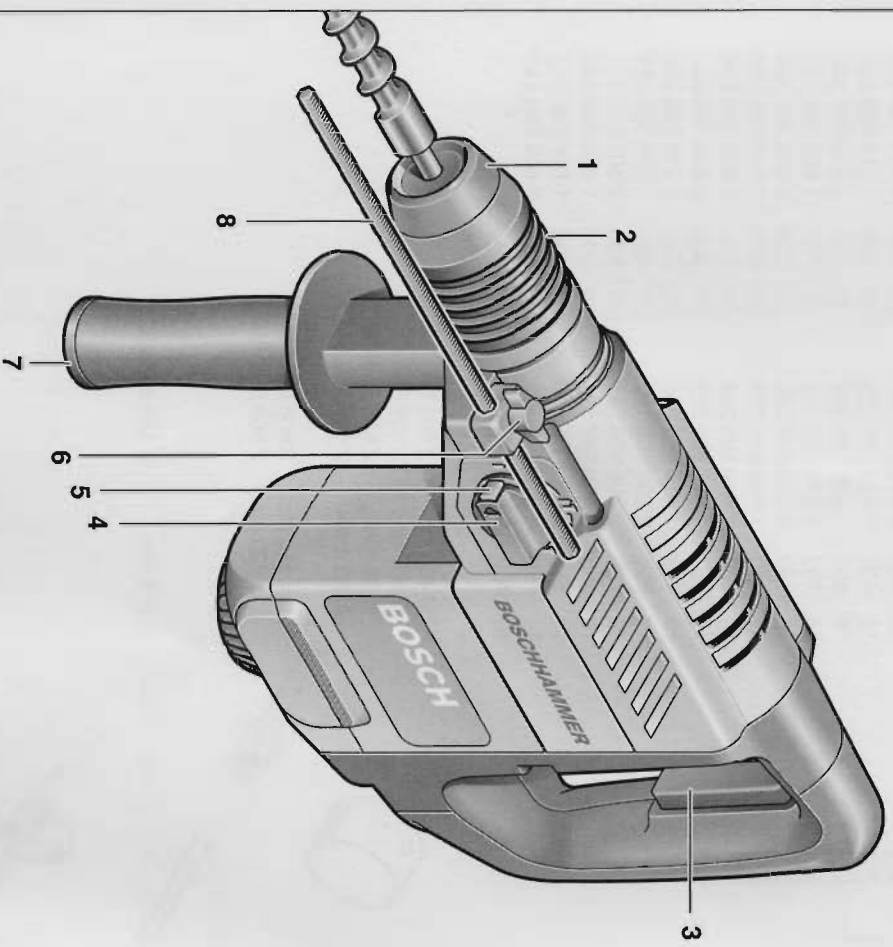

GBH 4 DFE

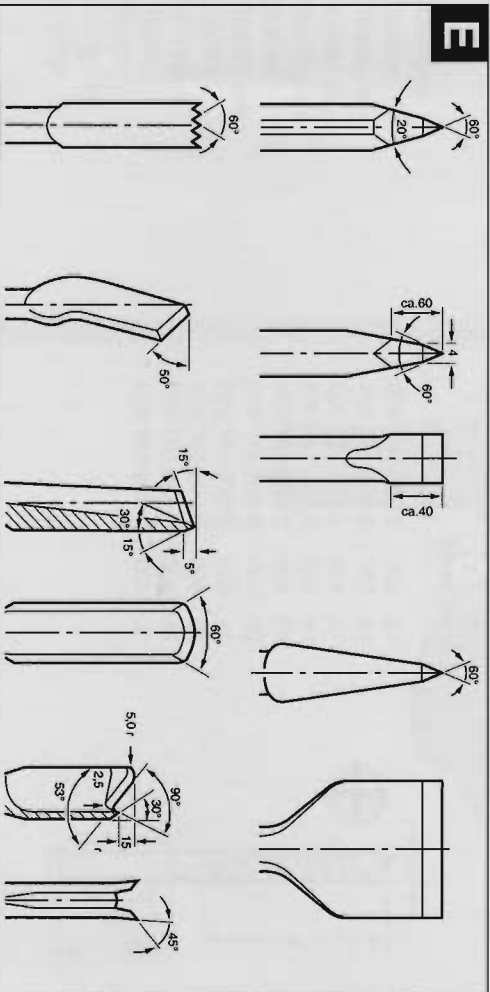
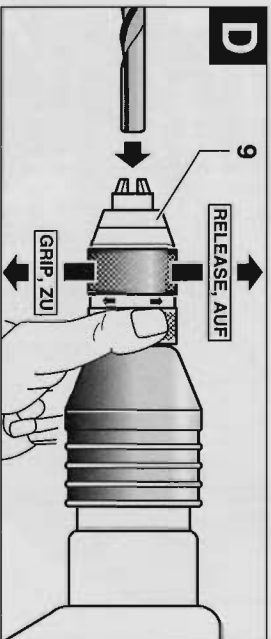
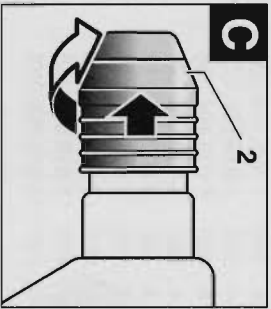
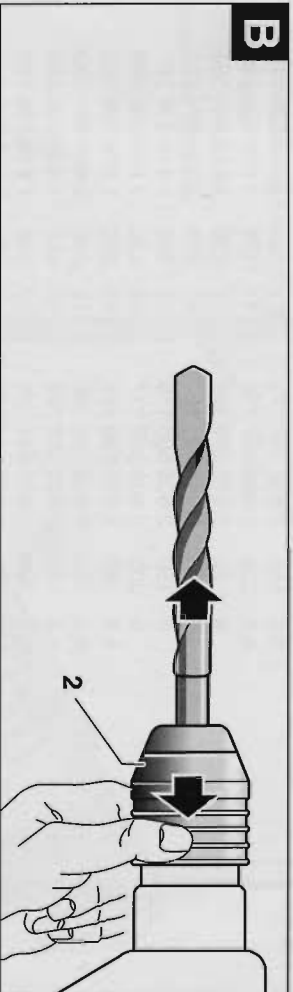
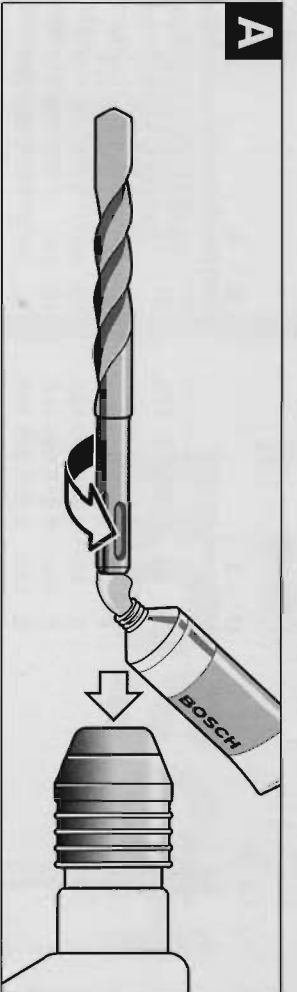

Tool Specifications

Rotary Hammer	GBH 4 DFE
Order number	0 611 236 7..
Rated power	[W] 750
Output power	[W] 440
Rated speed	[rpm] 0–650
Impact rate	[bpm] 0–3900
Impact energy per stroke	[J] 3.5
Chisel positions	36
Chiselling performance in concrete of medium hardness	[kg/h] 15
Tool holder	SDS-plus
Spindle collar diameter	[mm] Ø 51
Drilling output:	
- Concrete (twist drill bit)	[mm] 4–30
- Masonry (core bit)	[mm] max. 80
- Wood	[mm] max. 30
- Steel	[mm] max. 13
Weight (without accessories), approx.	[kg] 3.9
Protection class	□ / II

Please observe the order number of your machine. The trade names of the individual machines may vary.

Noise/Vibration Information

Measured values determined according to EN 50 144.

Typically the A-weighted noise levels of the product are: sound pressure level: 89 dB (A); sound power level: 102 dB (A).

Wear hearing protection!

The typically weighted acceleration is 11 m/s².

Machine Elements

- 1 Dust protection cap
- 2 Locking sleeve
- 3 On/Off switch
- 4 Mode selector switch
- 5 Release button
- 6 Wing bolt for depth stop adjustment
- 7 Auxiliary handle
- 8 Depth stop
- 9 Keyless chuck*

* Not all of the accessories illustrated or described are included as standard delivery.



For Your Safety



Working safely with this machine is possible only when the operating and safety information are read completely and the instructions contained therein are strictly followed. In addition, the general safety notes in the enclosed booklet must be observed. Before using for the first time, ask for a practical demonstration.

- Wear protective glasses and hearing protection.
- Wear sturdy shoes.
- For long hair, wear hair protection. Work only with closely fitting clothes.
- If the mains cable is damaged or cut through while working, do not touch the cable but immediately pull the mains plug. Never use the machine with a damaged cable.
- Connect machines that are used in the open via a residual current device (RCD) with an actuating current of 30 mA maximum. Use only extension cables that are approved for outdoor use.
- Always direct the cable to the rear away from the machine.
- Insert the mains plug only when the machine is switched off.
- Use the machine only with the auxiliary handle 7.
- Hold the power tool only by the insulated gripping surfaces, when performing an operation where the cutting tool may run into hidden wiring or its own cord.
Contact with a "live" wire will make exposed metal parts of the tool "live" and shock the operator.
- Use appropriate detectors to determine if utility lines are hidden in the work area or call the local utility company for assistance.
Contact with electric lines can lead to fire and electric shock. Damaging a gas line can lead to explosion. Penetrating a water line causes property damage or may cause an electric shock.
- When working with the machine, always hold it firmly with both hands and provide for a secure stance.

- Always switch the machine off and wait until it has come to a standstill before placing it down.
- Never allow children to use the machine.
- Bosch is only able to ensure perfect operation of the machine if the original accessories intended for it are used.

Intended Use

The machine is intended for hammer drilling in concrete, brick and stone as well as for light chiselling work. It is also suitable for drilling without impact in wood, metal, ceramic and plastic.

Changing the Tool

- **Before any work on the machine itself, pull the mains plug.**

With the SDS-plus tool holder, simpler and easier tool changing is possible without additional aids.

- ✎ **Grease the shank end of the tool regularly.**

The dust protection cap 1 largely prevents the entry of drilling dust during operation. When inserting the tool, take care that the dust protection cap 1 is not damaged.

- **A damaged dust protection cap should be changed immediately. We recommend having this carried out by an after-sales service.**

✎ As a requirement of the system, the SDS-plus tool must rotate freely. At no-load speed, this leads to a certain amount of radial run-out. This does not affect the accuracy of the drill hole, as the bit is automatically centred during drilling.

Inserting (see figure A)

Clean and grease the shank end of the tool. Insert the tool in a twisting manner into the tool holder until it locks. Check if it has locked by pulling the tool.

Removing (see figure B)

Push back the locking sleeve 2 of the tool holder and remove the tool.

Auxiliary Handle/Depth Stop

- **Use the machine only with the auxiliary handle 7.**

Loosen the handle by turning to the left. Rotate the auxiliary handle 7 and adapt to the working position.

Firmly retighten the handle.

The drilling depth can be set with the depth stop 8.

For this, loosen wing bolt for depth stop adjustment 6, set the required drilling depth X and tighten the wing bolt again.

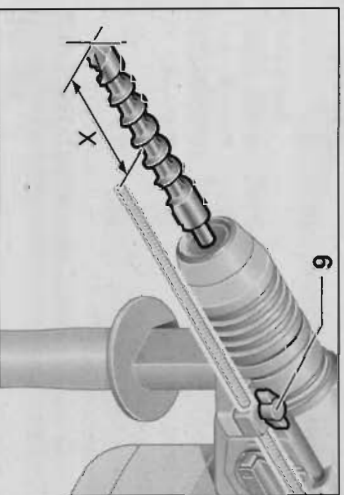

The ribbing on depth stop 8 must point upwards.

Initial Operation

Observe correct mains voltage: The voltage of the power source must agree with the voltage specified on the nameplate of the machine. Equipment marked with 230 V can also be connected to 220 V.

Switching On and Off

To start the machine, press the On/Off switch 3 and keep it depressed.

To switch off the machine, release the On/Off switch 3.

✎ For low temperatures, the machine reaches the full hammer/impact performance only after a certain time. This start-up time can be shortened by striking the drill/chisel against the floor one time.

Changing the Speed/Impact Rate

With the On/Off switch 3, the rotational speed/impact rate can be regulated between low and high speed/rate. Light pressure on the On/Off switch 3 results in a low rotational speed/impact rate, for example, for sensitive work such as hole starting. With increased pressure, the rotational speed/impact rate is increased.

Mode Selector Switch

- **Operate the mode selector switch 4 only when the machine is at a standstill.**

Press the release button 5 on the mode selector switch 4 and turn the switch to the desired position.



Drilling



Hammer drilling



Changing the chiselling position (Vario-lock)



Chiselling (rotation off)

Overload Clutch

⚠ If the drill bit jams or edges, the drive to the drill spindle is interrupted.

Due to the arising forces always hold the machine firmly with both hands and provide for a secure stance.

Changing the Chiselling Position (Vario-lock)

The chisel can be locked in 36 positions. In this manner, the optimum working position can be set for each application.

Insert the chisel in the tool holder.

Press the release button 5 and turn the mode selector switch 4 at the same time to the "Chisel (Vario-lock)" position.

Turn the tool holder to the desired chiselling position.

Allow the mode selector switch 4 to latch in the "Chiselling" position. The tool holder is locked in this position.

The mode selector switch 4 must always be locked in the "Chiselling" position when chiselling.

Change the SDS-plus Tool Holder

Removal (see figure C)

Set the mode selector switch 4 temporarily to the "Chiselling" position (drill spindle locked).

Turn the locking sleeve 2 firmly counter clockwise to the stop and pull off the tool holder.

Mounting

Place the tool holder on the drill spindle.

Turn the locking sleeve 2 counter clockwise (to the left) and press back firmly at the same time until the tool holder latches and locks itself. Ensure that the tool holder is firmly seated.